

PCCOM PCI 2 PORT HYBRID SERIAL ADAPTER

OPERATION MANUAL



DECISION

Computer International Co., Ltd.

11/6/04

..TABLE OF CONTENTS..

CHAPTERS

1. Introduction.....	1
2. Unpacking Information.....	3
3. System Requirements.....	4
4. Hardware Installation	5
5. Switch and Jumper Settings.....	6
6. RS232 Cabling Information.....	12
7. RS422/RS485 Cabling Information.....	16

APPENDICES

A. PCCOM Diagnostics Under MS/DOS	18
B. PCCOM Device Driver for MS/DOS.....	19
C. XENIX/UNIX Configuration	22
D. WINDOWS 95/98 Configuration	28
E. WINDOWS 2000 Configuration	30
F. WINDOWS/NT Configuration V3.5 up	32
G. OS/2 Configuration	34
H. Linux Configuration	38
I. Diagnostics Under Windows.....	39
J. Software Development Information.....	41
K. Warranty Information.....	45

<http://www.pccompci.com>

11/6/04

CHAPTER 1

INTRODUCTION

The PCCOM PCI bus 2 port hybrid adapter is an 32 bits PCI bus board with Plug and Play (PnP) features, it provides two asynchronous serial communication ports (one is RS232 port, another is RS422 or RS485 port), which link the computer and serial peripheral devices such as terminals, modems, serial printers, plotters, ... etc. The PCCOM PCI bus 2 port hybrid adapter can be used to set different communication mode (RS422 or RS485) for second port as user requires.

The PCCOM PCI bus 2 port hybrid adapter is particularly suited to facilitate the connection of terminals (VDUs) in multi-user operating systems. The PCCOM board may be installed in any Pentium or hardware compatible systems. The PnP features let hardware configuration for IRQ and I/O address is detected by BIOS automatically, you don't need set switch and jumper.

Since most of the computer has its own COM1 and COM2, the PCCOM PCI bus 2 port hybrid adapter can be configured from COM3.

On board ST16C550 chip provides 16 bytes FIFO buffer for each port. There are two kinds of mode can be choose, one is normal speed mode that its baud rate up to 115200, another is quadruple speed mode that its baud rate up to 460K.

The features of the PCCOM PCI bus 2 port hybrid adapter are:

- 32 bit PCI bus with Plug and Play (PnP) features.
- One RS232 port and one RS422 or RS485 port for asynchronous communications.
- User can set different communication mode (RS422 or RS485) for second port.
- Suitable for SCO UNIX, Linux, MS/DOS, WINDOWS NT/2000/XP, WINDOWS 95/98/ME, OS/2... etc.
- Pentium hardware compatibles.
- Baud rate up to 115200 for normal speed mode and up to 460K for quadruple speed mode.
- Provides 16550 port that contains 16 bytes FIFO for each port.
- Up to 4 boards be installed in one computer system.
- Software compatible with PCCOM98/2000.
- Operating temperature 0 to 60 °C.
- Storage temperature -20 to 70 degree °C.
- Humidity 5% to 95% in non-condensing.

CHAPTER 2

UNPACKING INFORMATION

 **Check that your PCCOM package includes the following items:**

- PCCOM PCI bus 2 port hybrid adapter.
- Expansion cable with standard 25 pin connectors or 9 pin connectors.
- User manual.
- Decision Studio CD for PCCOM software.
- Warranty form.

CHAPTER 3

SYSTEM REQUIREMENTS

 **Before installing your PCCOM PCI bus 2 port hybrid adapter, make sure that:**

- The host computer is a Pentium or its compatibles.
- The switch and the jumpers are properly configured.
- The operating system you intend to use is capable of driving multiple serial ports.

CHAPTER 4**HARDWARE INSTALLATION**

Your PCCOM PCI bus 2 port hybrid adapter is designed to be inserted in any available PCI slot in your Pentium or compatibles. You must plug this board to your computer before installing PCCOM software. In order to gain access to the expansion slots, follow the steps listed below:

1. Turn off all power to your computer and all peripheral devices before installing your PCCOM PCI bus 2 port hybrid adapter.
2. Remove the cover of the computer.
3. Set the SW1 to identify card number.
4. Insert the PCCOM PCI bus 2 port hybrid adapter into any available PCI slot. Make sure the adapter is firmly seated in the chosen slot.
5. Replace the cover of the computer.
6. Connect cables to D25 or DB9 connectors as required.
7. Turn on the power of your computer.

CHAPTER 5

SWITCH AND JUMPER SETTING

The Plug and Play features let hardware configuration for IRQ and I/O address is detected by BIOS automatically, so that it need not switch and jumper setting. The on board switch can be used to identify card number by the users (if you do not set the switch, the PnP BIOS will assign card number automatically).

JP1,JP2 (Jumper 1,2)

Select high speed mode or normal speed mode.

JP3 (Jumper 3)

Set RS422 or RS485 for second port.

SW1 (Switch 1)

Identifies card number.

Under the RS485 mode, all the RS485 Ports are set to receive mode automatically, while one port use to send data to the other port, it needs to set RTS signal to 1, to enter driver mode, then send message or data. After sending message, it needs to set signal to 0 to enter receive mode again.

DECISION Computer International Ltd.,

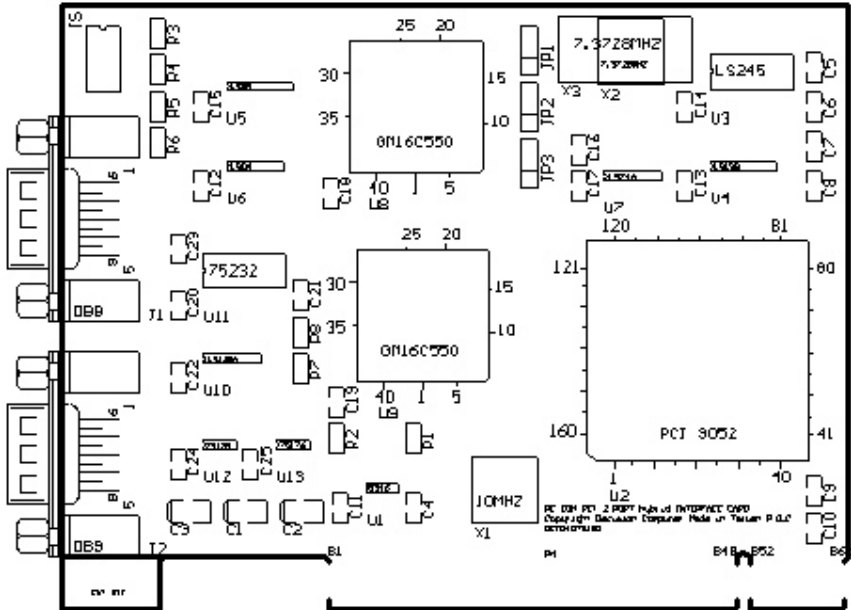

1. Select High Speed or Normal Speed Mode

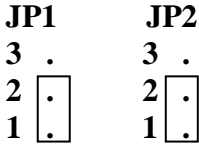

The JP1 is used to select high-speed mode or normal speed mode of RS232 port, and JP2 is used to select high-speed mode or normal speed mode of second port (RS422 or RS485); to select normal speed, please short pin 1 and 2, to select high speed, please short pin 2 and 3. The clock rate is 1.8432MHZ for normal speed mode. The baud rate speed up to 115200. The clock rate is 7.3728MHZ for high-speed mode. The baud rate speed up to 460K.

Pin	Mode
Short 1,2	Normal Speed
Short 2,3	High Speed

For normal speed mode, the user setting baud rate is the same as RS232 baud rate. We list in the following:

Original	RS232 on board baud rate
50	50
300	300
600	600
1200	1200
2400	2400
4800	4800
9600	9600
19.2K	19.2K
38.4K	38.4K
57.6K	57.6K
115.2K	115.2K

For high-speed mode, the user setting baud rate maps to on board RS232 baud rate are list in the following. Please note that, your device driver may report original baud rate, however the speed of communication line is quadruple speed.

Original	RS232 on board baud rate
50	200
300	1200
600	2400
1200	4800
2400	9600
4800	19.2 K
9600	38.4 K
19.2K	76.8 K
38.4K	153.6K
57.6K	230.4K
115.2K	460.8K

2. Set RS422 or RS485 Mode for Second Port

JP3

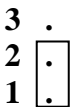

The JP3 is used to set RS422 or RS485 mode for second port, to short pin 1 and pin 2 means set RS422 mode, to short pin 2 and pin 3 means set RS485 mode.

Pin	Mode
Short 1,2	RS422
Short 2,3	RS485

3. Card Identifier

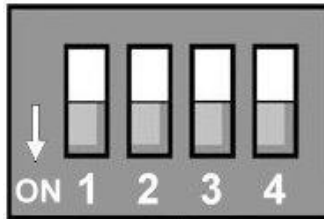

The switch is used to identify card number, default setting is card 15, and there are two methods to set the card number:

a. PnP mode

Just plug in PCCOM PCI bus 2 port adapter into PCI slot, the PCI BIOS will allocate I/O address to each adapter automatically and assign card number start from 0 to each adapter. **You may set any card number at PnP mode, and you need use software tools to distinguish port id. Almost all of the operating systems run at PnP mode.**

b. manual mode

Set card number by card identifier switch, the PCI BIOS will assign pre-allocated I/O address to each adapter. Please set different card number to each adapter (do not duplicate card number setting).

1	2	3	4	Card Number
OFF	OFF	OFF	OFF	15
ON	OFF	OFF	OFF	14
OFF	ON	OFF	OFF	13
ON	ON	OFF	OFF	12
OFF	OFF	ON	OFF	11

ON	OFF	ON	OFF	10
OFF	ON	ON	OFF	9
ON	ON	ON	OFF	8
OFF	OFF	OFF	ON	7
ON	OFF	OFF	ON	6
OFF	ON	OFF	ON	5
ON	ON	OFF	ON	4
OFF	OFF	ON	ON	3
ON	OFF	ON	ON	2
OFF	ON	ON	ON	1
ON	ON	ON	ON	0

☞ The card number starts from 0 to 15.

CHAPTER 6

RS232 CABLING INFORMATION

6.1 DB25 Connector

The communication interface follows the EIA RS232 standard. The signal assignments for a standard DB25 connector are shown below:

Pin #	DB25 Signal Name	RS-232C Name	Signal Direction
1	Chassis Ground(GND)	AA	Common
2	Transmit Data(TxD)	BA	Output
3	Receive Data(RxD)	BB	Input
4	Request to Send(RTS)	CA	Output
5	Clear to Send(CTS)	CB	Input
6	Data Set Ready(DSR)	CC	Input
7	Signal Ground(SG)	AB	Common
8	Data Carrier Detect(DCD)	CF	Input
20	Data Terminal Ready(DTR)	CD	Output
22	Ring Indicator(RI)	CE	Input

25 – PIN D-SHELL

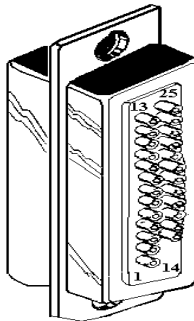

To connect the PCCOM adapter to other DATA TERMINAL EQUIPMENT (DTE) devices, we recommend using a DTE to DTE connection as shown below:

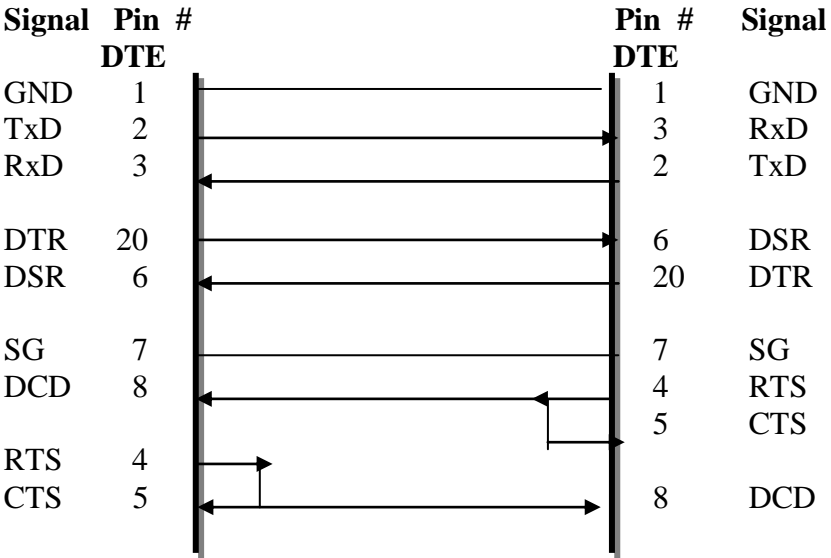

6.2 Null Modem Connections: RS232

If the software supplier or operating system does not specify a particular cable configuration, we recommend you use the following “null modem” cable when XON/XOFF is utilized.

HOST	REMOTE
2	3
3	2
4	4
5	5
6	6
7	7
8	8
20	20

If hardware handshaking is necessary, use the following cable:

HOST	REMOTE
2	3
3	2
4	4
5	5
6	20
7	7
8	8
20	6

Some serial devices have the buffer control signal on pin 19, in which case pin 6 on the host is connected to pin 19 on the remote device.

6.3 Modem Connections

A straight through cable is required, e.g. pin 2 to pin 2, pin 3 to pin 3, etc.

HOST	REMOTE
2	2
3	3
4	4
5	5
6	6
7	7
8	8
20	20

6.4 DB9 Connector

The signal assignments for a standard DB9 connector are shown below:

Pin #	DB9 Signal Name	RS-232C Name	Signal Direction
1	Data Carrier Detect(DCD)	CF	Input
2	Receive Data(RxD)	BB	Input
3	Transmit Data(TxD)	BA	Output
4	Data Terminal Ready(DTR)	CD	Output
5	Chassis Ground(GND)	AA	Common
6	Data Set Ready(DSR)	CC	Input
7	Request to Send(RTS)	CA	Output
8	Clear to Send(CTS)	CB	Input

CHAPTER 7

RS422/RS485 CABLING INFORMATION

7.1 RS422 Cabling Information for DB25

The communication interface follows the EIA RS422 standard. The signal assignments for DB25 connector are shown below:

Pin	Description
1	Chassis Ground
7	Signal Ground(SG)
12	Transmit Data+(TxD+)
13	Receive Data+(RxD+)
24	Transmit Data-(TxD-)
25	Receive Data-(RxD-)

To connect the RS422 to other DATA TERMINAL EQUIPMENT (DTE) devices, the developers recommend using a DTE to DTE connection as shown below.

HOST	REMOTE
Ground	Ground
Signal Ground	Signal Ground
Transmit Data(+)	Receive Data(+)
Receive Data(+)	Transmit Data(+)
Transmit Data(-)	Receive Data(-)
Receive Data(-)	Transmit Data(-)

7.2 RS422 Cabling Information for DB9

The communication interface follows the EIA RS422 standard. The signal assignments for a standard DB9 connector are shown below:

Pin	Description
2	Receive Data+(RxD+)
3	Transmit Data+(TxD+)
4	Transmit Data-(TxD-)
5	Signal Ground(SG)
6	Receive Data-(RxD-)

7.3 RS485 Cabling Information for DB9

The RS485 signal assignment is shown as follows.

Pin	Description
2,3	Transmit Data+/ Receive Data+(TRD+)
5	Signal Ground
4,6	Transmit Data-/Receive Data-(TRD-)

TRD+ signal means short pin 2 and pin 3, and TRD- signal means short pin 4 and pin 6. The RS485 communication is based on cable sharing method, which is connected as following:

Computer at site 1	Computer at site 2
TRD+	TRD+
TRD-	TRD-
Ground	Ground

APPENDIX A**PCCOM DIAGNOSTIC UNDER MS/DOS**

The TESTCOM is a diagnostic program, provide routines to test your PCCOM PCI 4 port serial adapter under MS-DOS. It has both internal and external loopback tests. During external loopback test, a loop back plug must be connected to each port being tested. You can also select different hardware settings during testing from the SETUP RS232/RS422 menu.

User can get TESTCOM program from Decision Studio CD.

i To test your PCCOM 4 port adapter under MS/DOS, please type

TESTCOM

The TestCom menu will appear.

Setup RS232/RS422 – is used to setup the baud rate, etc.

Internal loop test – is used to test the IC.

External loop test – is used to test the ports.

Auto – is used to test the IC and the ports of the card.

APPENDIX B**PCCOM DEVICE DRIVER FOR MS/DOS*****B.1 PCCOM Software***

The PCCOM software is a high performance, easy to use RS232/RS422 device driver for PC/486, Pentium or compatibles. Under MS/DOS environment, you can set up your serial ports by PCCOM device driver, and these serial ports can be treated as COM1: and COM2: devices. The setup procedure provides flexible functions to specify the configuration of multi-serial card, that is, the hardware configurations of I/O port number, I/O port address, interrupt and interrupt vector are user selectable.

After the device driver is installed, It takes over communication between CPU and multi-serial cards such as four port card, eight port card, ... etc. For each I/O port, the service routine handles a ring buffer to keep track of all I/O data. Moreover, the PCCOM software provides library routines (C, PASCAL, BASIC, FoxPro) and DOS communication interface (DOS device driver, BIOS call) for several access levels.

 *For more details, please refer PCCOM manual.*

B.2 Software Installation

When the board is installed, please install software drivers as follows:

STEP 1: Prepare PCI.OPT file

The PCI.OPT file contents are :

```
/B:4  
/D:COM3  
/P:[:4:(2k:9600:N-8-1:RTS+DTR:XON) * 4]
```

STEP 2: Prepare CONFIG.SYS file

Insert statement into CONFIG.SYS file

For normal speed

```
DEVICE = PCCOM.SYS @c:\pci.opt
```

For high speed

```
DEVICE = PCCOMH.SYS @c:\pci.opt
```

The syntax of PnP function is

```
/P:[Card_id:Portno:Port]
```

The Card_id field is defined as 1 or 2 or 3 or 4 or nil, if you use PnP mode, just fill nil in card_id field that like step 1, otherwise you can specify card_id to match the card identifier switch. The Portno field is used to specify number of ports in this adapter. The Port field is defined as PCCOM V2.0.

- ☞ If more than one PCCOM board is installed, Please repeat directive /P of the step 1.

APPENDIX C

XENIX / UNIX CONFIGURATION

The distribution CD contains SCO UNIX driver. Our drivers also provide transparent printer features that let user to connect local printer from auxiliary port of terminal. The PCI BIOS will assign card number automatically when you use PnP method, otherwise you can use card identifier switch to set your card number. The software installation procedures are shown is the bellows.

C.1 Hardware Configuration

1. First adapter

Port	Device Name	MODEM Name	Transparent Printer Name
1	/dev/ttyj11	/dev/ttyJ11	/dev/lpj11
2	/dev/ttyj12	/dev/ttyJ12	/dev/lpj12
3	/dev/ttyj13	/dev/ttyJ13	/dev/lpj13
4	/dev/ttyj14	/dev/ttyJ14	/dev/lpj14

2. Second Adapter

Port	Device Name	MODEM Name	Transparent Printer Name
1	/dev/ttyj21	/dev/ttyJ21	/dev/lpj21
2	/dev/ttyj22	/dev/ttyJ22	/dev/lpj22
3	/dev/ttyj23	/dev/ttyJ23	/dev/lpj23
4	/dev/ttyj24	/dev/ttyJ24	/dev/lpj24

3. Third Adapter

Port	Device Name	MODEM Name	Transparent Printer Name
1	/dev/ttyj31	/dev/ttyJ31	/dev/lpj31
2	/dev/ttyj32	/dev/ttyJ32	/dev/lpj32
3	/dev/ttyj33	/dev/ttyJ33	/dev/lpj33
4	/dev/ttyj34	/dev/ttyJ34	/dev/lpj34

4. Fourth Adapter

Port	Device Name	MODEM Name	Transparent Printer Name
1	/dev/ttyj41	/dev/ttyJ41	/dev/lpj41
2	/dev/ttyj42	/dev/ttyJ42	/dev/lpj42
3	/dev/ttyj43	/dev/ttyJ43	/dev/lpj43
4	/dev/ttyj44	/dev/ttyJ44	/dev/lpj44

C.2 Software Installation

[i] The installation procedure for the device drivers is described as follows:

- ➊ Login as a root user.
- ➋ Insert distribution CD (which contains device drivers) into CD-ROM drive d:, then copy the files from the distribution CD to a temporary directory.

```
#cd /
# doscp d:dc.tz ./dc.tar.Z
# zcat dc.tar / tar xvfp -
```

- ③ To install device drivers, please type:

```
#cd /usr/sys/pccom/dc  
# ./install
```

- ④ Reboot the system. Now, your new UNIX system that includes device drivers is activated.
- ⑤ Enable each terminal by using the **enable** command.

```
# enable ttyj11  
# enable ttyj12  
.  
.
```

- ⑥ Connect each terminal to connector.

NOTE:

- ① If the new system fails to reboot, please boot the original system. When system is boot, please press return key to halt autoboot, then type

```
:unix.old
```

- ② To remove device driver from UNIX, please type

```
a. login as a root user  
b. # cd /usr/sys/pccom/dc  
c. Remove PCCOM Driver from the kernel  
#./ remove
```

- ③ After installation, please enable each port by **enable** command and disable port by **disable** command.

```
#disable ttyj11
```

- ④ To change baud rate, please update /etc/inittab and /etc/conf/cf.d/init.base files.

C.3 Transparent Printer

The default device names to Transparent Printer(TP) are /dev/lpXYY, that is, the prefix name is changed from "tty" to "lp" but the other "XYY" is the same. e.g. under default device names, the corresponding TTY line of /dev/lpj11 is /dev/ttyj11.

By multiplexing a serial line, there are two sorts of data channels for TTY data(by /dev/ttyXYY) and TP data(by /dev/lpXYY). If the /dev/ttyj11 is used for a TTY, it has to be enabled before you would like to print data through /dev/lpj11 to a printer that connected to the terminal that is operated via /dev/ttyj11.

The channel for TP data that is uni-directional is used to transmit the data from a host to a terminal only. The differentiates of TTY data and TP data in the same serial line is that TP data are encapsulated within a couple of PRINT-ON and PRINT-OFF escape strings that are recognized by connected terminals. The PRINT-ON and PRINT-OFF is defined by connected terminals.

The scheme to multiplex a serial line for these two channels is based on time-division method. The time slices for TTY or TP data are generated according to the entry procedure, polling, in the PCCOM driver, which is periodically called by system clock. The period of



```
Interval for TTY : 50
Interval for TP : 1
PRINT - ON escape : "\033[5i" (ESC[5i)
PRINT - OFF escape : "\033[4i" (ESC[4i)
```

☞ The examples to invoke lpx

- 1 Set 60 time slices reserved for /dev/ttyj11

```
# lpx -t 60 /dev/ttyj11
```

- 2 Set 2 time slices reserved for /dev/lpj11

```
# lpx -12 /dev/lpj11
```

- 3 Get the time slices reserved for /dev/lpj11

```
# lpx -L /dev/lpj11
```

- 4 Set PRINT-ON string for /dev/lpj11

```
# lpx -n "\033[51" /dev/lpj11
```

- 5 Get PRINT-OFF string for /dev/lpj11

```
# lpx -F /dev/lpj11 \033[4i
```

APPENDIX D

WINDOWS95/98 CONFIGURATION

Welcome to the Decision PCCOM PCI cards series. This series enables you to utilize the built in plug and play functionality of Windows 95/98, combined with the power of PCI based serial communication.

D.1 Installation

1. For optimum PnP functionality, please install one card at a time.
 2. Unplug your PC, open it and install one Decision PCCOM PCI card.
 3. Start your computer and wait until Windows 95/98 is loaded.
 4. Windows 95/98 will detect the new PCI card that is installed in your computer, and will prompt you for a proper driver.
 5. Insert the device driver CD into your computer, and make sure Windows 95/98 finds the drivers by eventually browsing through the directory structure of the CD.
 6. After installing the core device drivers for the PCI card, Windows 95/98 will detect and install software for each COM port on the card. This may take 5 to 10 seconds per port.
 7. After Windows 95/98 has detected and configured all ports, you may begin using the PCI card. To verify that the installation process completed successfully, please proceed into the Control Panel / System / Device Manager.
 8. Locate the additional COM ports in the ports section.
- ☞ If you need install more than one card, please run above procedure again. Never try to install 2 or more cards at the same time for you will have errors in installation.

D.2 Remove Ports



1. Go to [Control Panel Applet]\[System]\[Device Manager]\[Ports].
2. Select the port you want to remove then press “Remove” to delete specified port. Reboot for changes to take effect.



APPENDIX E

WINDOWS2000 CONFIGURATION

Welcome to the Decision PCCOM PCI cards series. This series enables you to utilize the built in plug and play functionality of Windows 2000, combined with the power of PCI based serial communication. During the boot-up of Windows 2000 the hardware will be automatically detected by the WINDOWS 2000, just ignore this dialog box by clicking **cancel** and during login, use the administrator user name for installation

E.1 Installation

1. For optimum PnP functionality, please install one card at a time.
2. Unplug your PC, open it and install one Decision PCCOM PCI card.
3. Start your computer and wait until Windows 2000 is loaded.
4. Windows 2000 will detect the new PCI card that is installed in your computer, and will prompt you for a proper driver.
5. Insert the device driver CD into your computer, and make sure Windows 2000 finds the drivers by eventually browsing through the directory structure of the CD.
6. After installing the core device drivers for the PCI card, Windows 2000 will detect and install software for each COM port on the card.
7. After Windows 2000 has detected and configured all ports, you may begin using the PCI card. Inside the Control Panel, you will see the Icon of **Decision PCCOM Adapters**, indicating that the driver has been successfully installed..
8. Double click the Icon **Decision PCCOM Adapters**, another window will appear on screen and will display an installed card with corresponding COM port.

☞ If you need install more than one card, please run above procedure again. Never try to install 2 or more cards at the same time for you will have errors in installation.

E.2 Remove Ports

1. Go to [Control Panel Applet]\[Decision PCCOM Adapters].
2. Select the port you want to remove then press “Remove Port” to delete specified port. Reboot for changes to take effect.

APPENDIX F

WINDOWS/NT CONFIGURATION V3.5 up

Welcome to the Decision PCCOM PCI cards series. This series enables you to utilize the built in plug and play functionality of Windows NT, combined with the power of PCI based serial communication.

F.1 Installation

1. For optimum PnP functionality, please install one card at a time.
2. Unplug your PC, open it and install one Decision PCCOM PCI card.
3. Start your computer and wait until Windows NT is loaded.
4. Insert the device driver CD into your computer. The CD is auto run, so you just wait until Decision Studio Applet appears.
5. Click “Device Drive” button, “Windows Operating System” then a selection of windows operating system platform appears.
6. Click “Windows NT” button to view the device list of different hardware products.
7. Select “PCCOM Multi Port Serial Card”. Install Shield will do installation, for you just click “Next” When windows prompts you to resume installation procedure.
8. To configure, go to [Control Panel]\[Decision PCCOM Adapters]. Click the “+” of the card you want configure, then select which COM port you want to set.

F.2 Remove Ports

Go to [Control Panel]\[Ports] then select what you want to remove and click “Delete” to remove ports.

F.3 Uninstall



Enter [Control Panel]\[Decision PCCOM Adapter], and click [Completely Remove Driver].



APPENDIX G

OS/2 CONFIGURATION

Under OS/2 2.x and OS/2 Warp operating system, the PCCOM device driver provides total 96 ports and baud rate up to 115200. PCCOM also supports device driver for high speed card, and the baud rate can be up to 1M. The device driver works for 8250, 16450, 16550 (FIFO), 16850(FIFO) etc.

G.1 Installation

The installation procedures are shown in the following.

1. Add command into CONFIG.SYS file then reboot.

DEVICE=C:\PCCOM4PC.SYS[/Cxx] [/Syy] [/4]

- xx Assign the first port name (1 to 92)
- yy The switch used to set PCI card number
- 4 High speed card used only

- ☞ If "/C" is not use, the first port is COM3.
- ☞ If you only install one card, you can ignore /S parameters.
- ☞ If you install more than one card, you must set different card number. (Please refer chapter 5)

Switch: Set card number

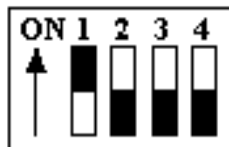

- ■ ■ 2. ■ ■ ■ To set up communication parameters, please use the MODE.COM command from OS/2, or use PCCOM.EXE command. We highly recommend to use PCCOM.EXE command, because MODE.COM can be used only for COM1 to COM9 and for maximum baud rate to 57600.

The PCCOM.EXE can be used to set COM1 to COM96. The syntax of PCCOM.EXE is the same as MODE.COM.

- *For example :*

1. Set one PCI 4 port card from COM3 to COM6.

```
DEVICE=C:\PCCOM4PC.SYS
```

2. Set two cards. One card is PCI 4 port card, which is set from COM12 to COM15, and its card number is 0. One card is PCI 8 port card, which is set from COM20 to COM27, and its card number is 1.

```
DEVICE=C:\PCCOM4PC.SYS /C12/S0
DEVICE=C:\PCCOM8PC.SYS /C20/S1
```

3. Set up communication parameters.

```
C:\PCCOM COMx:38400,N,8,1,TO=OFF,XON=OFF,
IDSR=ON, ODSR=ON, OCTS=ON, RTS=OFF,DTR=OFF
C:\PCCOM COMx:115200,N,1
```

G.2 Utilities

COMTEST.EXE is a general testing program for COM port. It will create the threads associated with each communication port that will be test. The testing function includes OPEN / CLOSE / READ / WRITE / Non-Destructive Read / Non-Destructive WRITE / Get Status / Device IOCTL. Due to lack of OS/2 API, Non-Destructive I/O is not support for OS/2 even this device driver has implemented this feature.

In the COMTEST program, you can use up-right arrow to choice the option, and use enter/escape to start/stop the program.

The ComSent / ComRecv are a pair of communication programs for testing the performance of communication port. You have to connect the test ports with a null modem before you test communication port. You can use PCCOM.EXE to change the parameters of communication port. Then use this program to test heavy (transmission) duty on communication port.

G.3 API Communication Functions

In the following, there are API communication functions, for more detail information, please refer to Control Program Programming Ref. of OS/2, and programming Guide Vol. I-III of OS/2.



DosClose - Close a Handle to a File, Pipe, or Devices
#define INCL_DOSFILEMGR APIRET DosClose(HFILE
FileHandle);



DosDevConfig - Get Information about Attached Devices
#define INCL_DOSPROCESS APIRET DosDevConfig(PVOID
pDeviceInfo, ULONG ulDeviceType);

DosDevIOCtl - Perform Control Function on a Device

Specified by an Opened Device Handle
#define INCL_DOSPROCESS APIRET DosDevIOCtl(HFILE
DevHandle, ULONG ulCategory, ULONG ulFunction, PVOID
pParmList, ULONG ulParmLengthMax, PULONG
pParmLengthInOut, PVOID pDataArea, ULONG
ulDataLengthMax, PULONG pDataLengthInOut);

DosOpen - Open a File

#define INCL_DOSFILEMGR APIRET DosOpen(PSZ
pszFileName, PHFILE ppFileHandle, PULONG pActionTaken,
ULONG ulFileSize, ULONG ulFileAttribute, ULONG
ulOpenFlag, ULONG ulOpenMode, PEAOP2 ppEABuf);

DosRead - Read from a File, Pipe, or Device to a Buffer

#define INCL_DOSFILEMGR APIRET DosRead(HFILE
FileHandle, PVOID pBufferAre, ULONG ulBufferLength,
PULONG pByteRead);

DosWrite - Write to a File from a Buffer

#define INCL_DOSFILEMGR APIRET DosWrite(HFILE
FileHandle, PVOID pBufferArea, ULONG ulBufferLength,
PULONG pByteWritte);

APPENDIX H

LINUX CONFIGURATION

The PCCOM 4 port adapter can be installed in the Linux by using serial device driver supported by Linux. For more details, please refer to 'setserial' man-pages.

☞ *Please uncomment the appropriate lines in /etc/rc.d/rc.serial to enable auto-configuration of PCCOM PCI bus 4 port card.*

For example, uncomment the following lines for PCCOM PCI bus 4 port card.

```
${SETSERIAL} /dev/cua4 ${AUTO_IRQ} autoconfig${STD_FLAGS}  
${SETSERIAL} /dev/cua5 ${AUTO_IRQ} autoconfig${STD_FLAGS}  
${SETSERIAL} /dev/cua6 ${AUTO_IRQ} autoconfig${STD_FLAGS}  
${SETSERIAL} /dev/cua7 ${AUTO_IRQ} autoconfig${STD_FLAGS}
```

APPENDIX I

DIAGNOSTIC UNDER WINDOWS

After installing the PCCOM PCI 4 port adapter to your computer, you can test it if it is functioning correctly via HyperTerminal (a Windows package communication program), or by using the Decision Terminal (a software of the Decision Computer International Co. Ltd.) included on the CD. Just make sure that there is a loop back plug connected to the COM Port under test.

1.1 Using Hyper Terminal

To test the card using the Hyper Terminal. Please do the following steps:

1. Run the HyperTerminal program.
2. During connection, the program will ask you to enter your name and choose an icon for the connection. Enter any name and select any icon.
3. After entering your name and selecting icon you will be ask for country code, area code, phone number and connect using what. Ignore all edit box except for the connect using, click the combo box and select Direct to COMx (You can use any port but usually the COM1 and COM2 is used by the computer motherboard).
4. Put the proper COM x properties.
5. You can now begin to type any message. Take note that

whatever you type must appear to the textbox as long as
■■■■■■ you have a loop back on the COM port of your card ■■■■■■

1.2 Using Decision Terminal

To test the card using the Decision Terminal. Please do the following steps:

1. Install the software using the Decision Studio (It is inside the CD AutoOpen program).
2. Run the program (Decision Terminal) at the program menu of the start menu.
3. Setup the COM port properties by selecting the setup option on the File menu.
4. You can now begin to type any message to transmit textbox. Take note that whatever you type must appear to receive textbox as long as you have a loop back on the COM port of your card.
5. You can also click the Test button to test your card automatically.

APPENDIX J**SOFTWARE DEVELOPMENT
INFORMATION**

In the Decision Studio CD, it contains PCCOM device driver for WINDOWS 3.1/95/98/2000/NT/ME/XP, DOS, OS/2, UNIX, Linux, and the development tools for serial communication and telecommunication.

J.1 PCCOM Professional

The PCCOM Professional is the Serial Communication Software Development Tool Kits Under Windows 95/98/2000/NT/ME/XP. It contains Complete OCX and DLL Microsoft Win32 API software accessory function for application software developer. It is an easy to use tool and speed up serial communication application software development time and cost. Wide compatibility range hardware support for PCCOM multiport serial card and any standard port, and support Zmodem and Kermit file transfer protocols for ASCII, Text and Executable file.

J.2 PCCOM RemoteCom

The PCCOM RemoteCom is an OCX programming development tool for made application software. That will use to enhance RS-232/422 serial communication through Internet or Intranet by stand-alone program or by browser through World Wide Web (WWW) under Windows 95/98/2000/NT/ME/XP. User may call OCX functions to communicate with RemoteCOM both Server and Client using Internet communication; or encapsulate OCX function and remote serial ActiveX Control, then run development application

program under Internet browser (IE and Netscape).

J.3 PCCOM TeleCom

The PCCOM TeleCom is an OCX software accessory suitable for software engineer to develop application program under Windows 95/98/2000/NT/ME/XP environment. It really makes computer and communication application combine together. Wide compatibility range hardware support for PCCOM multiport serial card and any standard port. The PCCOM TeleCom software kit supports five major telecommunication functions, which can be used to

1. Send message to "PAGER"(BB Call).
2. Send and receive "VOICE MAIL" from computer to telephone or portable phone.
3. Send and receive E-MAIL.
4. Send and receive FAX.
5. Receive DTMF.

J.4 PCCOM RemoTeleCom

The PCCOM Remote TeleCom is an OCX programming development tool for made application software. That will use to enhance PCCOM TeleCOM functions (Pager, E-mail, Voice mail, Fax) through Internet or Intranet by stand-alone program or by browser through World Wide Web (WWW) under Windows 95/98/2000/NT/ME/XP. User may call OCX functions to communicate with Remote devices both Server and Client using Internet communication; or encapsulate OCX function and remote ActiveX Control, then run development application program under Internet browser (IE and Netscape).

Remote Chat

This development tool is used for chatting / communicating with another computer in the Internet / Intranet.

Remote White Board

This development tool uses client – server remote drawing board, every client can shared their image drawn on server drawing board.

Remote Image Capture

This development tool allows you to capture images taken from the CCD camera via Internet.

Pinger

This development tool make it possible for you to make a program that check if your still connected to the network or internet and check the speed of the response of your connection!

Internet Location Server

This development tool is used to find an IP address of a particular client / computer in the Internet by just specifying its email address!

Remote Access Server

This development tool use to dial-up like and phone dialer technology, able to dial an ISP and monitor some of some IP address on network

APPENDIX K**WARRANTY INFORMATION*****K.1 Copyright***

Copyright DECISION COMPUTER INTERNATIONAL CO., LTD. All rights reserved. No part of PCCOM software and manual may be reproduced, transmitted, transcribed, or translated into any language or computer language, in any form or by any means, electronic, mechanical, magnetic, optical, chemical, manual, or otherwise, without the prior written permission of DECISION COMPUTER INTERNATIONAL CO., LTD.

Each piece of PCCOM package permits user to use PCCOM only on a single computer, a registered user may use the program on a different computer, but may not use the program on more than one computer at the same time.

Corporate licensing agreements allow duplication and distribution of specific number of copies within the licensed institution. Duplication of multiple copies is not allowed except through execution of a licensing agreement. Welcome call for details.

K.2 Warranty Information

DECISION warrants that for a period of one year from the date of purchase (unless otherwise specified in the warranty card) that the goods supplied will perform according to the specifications defined in the user manual. Furthermore that the PCCOM product will be supplied free from defects in materials and workmanship and be fully functional under normal usage.

In the event of the failure of a PCCOM product within the specified warranty period, DECISION will, at its option, replace or repair the item at no additional charge. This limited warranty does not cover damage resulting from incorrect use, electrical interference, accident, or modification of the product.

All goods returned for warranty repair must have the serial number intact. Goods without serial numbers attached will not be covered by the warranty.

Transportation costs for goods returned must be paid by the purchaser. Repaired goods will be dispatched at the expense of PCCOM.

To ensure that your PCCOM product is covered by the warranty provisions, it is necessary that you return the Warranty card.

Under this Limited Warranty, DECISION's obligations will be limited to repair or replacement only, of goods found to be defective as specified above during the warranty period. DECISION is not liable to the purchaser for any damages or losses of any kind, through the use of, or inability to use, the PCCOM product.

DECISION reserves the right to determine what constitutes warranty repair or replacement.

Return Authorization: It is necessary that any returned goods are clearly marked with an RA number that has been issued by DECISION. Goods returned without this authorization will not be attended to.